



Factureren aan:
Naam:
Straat:
Plaats: Postcode:
E-mail:
Tel: Fax:

Leveren aan:
Naam:
Straat:
Plaats: Postcode:
E-mail:
Tel: Fax:

Order datum:
Inkooporder:
Uw referentie:



Gemarkeerd voor:
Sunrise ordernr.:

- Order
 Offerte

- = Standaard = Meerprijs
 = Geen meer-/minderprijs



Customer Service: cs@sunrisemedical.nl

Max. gebruikersgewicht: kg
Gebruikersgewicht: kg

Altijd invullen voor juiste configuratie

Basisprijs vanaf € 4.045,- (exclusief BTW)

Geldig tot eerstvolgende wijziging of uiterlijk 31-12-2025.

Wijzigingen voorbehouden. Op alle transacties zijn de algemene voorwaarden van Sunrise Medical HCM B.V. van toepassing.
Deze algemene voorwaarden zijn te raadplegen op www.sunrisemedical.nl/algemene-voorwaarden

ATTITUDE - MODEL SELECTEREN

| | | | |
|-----------|---|-------------------|----------------|
| ATT010801 | <input type="checkbox"/> ATTITUDE Manual Terugtraprem, 8 versnellingen (naaf), voor- en achterverlichting; snelheidsmeter; fietsstandaard voorzien van wieltjes; handvatten; v-crank. | Basisprijs | € 4.045 |
| ATT010802 | <input type="checkbox"/> ATTITUDE Hybrid 10 versnellingen cassette; trigger shifter; 17 Ah Lithium-ion accu; ondersteuning tot max 25 km/u; voor- en achterverlichting; fietsstandaard voorzien van wieltjes, handvatten; v-crank, schijfrem; snelheidsmeter geïntegreerd in het scherm | Basisprijs | € 7.434 |
| ATT072102 | ◆ Kleurendisplay, inclusief smartphone connectie via bluetooth | | |
| ATT010803 | <input type="checkbox"/> ATTITUDE Power Snelheid maximaal 15 km/u (standaard); handvatten; schijfrem; 9 Ah Lithium-ion accu; voor- en achterverlichting; fietsstandaard voorzien van wieltjes, snelheidsmeter geïntegreerd in het scherm | Basisprijs | € 6.079 |
| ATT072111 | ◆ Handgas positie rechts | | |
| ATT072112 | <input type="checkbox"/> Handgas positie links | | € 54 |

AFMETINGEN ROLSTOEL

ROLSTOELMODEL - rolstoel type welke wordt gecombineerd met de ATTITUDE

| |
|---|
| <input type="checkbox"/> Life T (alleen vast voorframe) |
| <input type="checkbox"/> Life RT (alleen vast voorframe) |
| <input type="checkbox"/> Life (alleen vast voorframe) |
| <input type="checkbox"/> Life R (alleen vast voorframe) |
| <input type="checkbox"/> Easy 200 |
| <input type="checkbox"/> QS5 X |
| <input type="checkbox"/> Xenon / Xenon ² (alleen vast voorframe) |
| <input type="checkbox"/> Argon ² |
| <input type="checkbox"/> Nitrum |

| | |
|---|-----|
| <input type="checkbox"/> Invacare Kuschall K-serie * / ** | 648 |
| <input type="checkbox"/> Invacare Kuschall KSL * | 648 |
| <input type="checkbox"/> Invacare Kuschall Advance * | 330 |
| <input type="checkbox"/> Invacare Kuschall Champion * | 330 |
| <input type="checkbox"/> Otto Bock Avantgarde CS * | 450 |
| <input type="checkbox"/> Otto Bock Avantgarde CLT * | 450 |
| <input type="checkbox"/> Otto Bock Motus CS * | 450 |
| <input type="checkbox"/> RGK Tiga * | 330 |
| <input type="checkbox"/> TNS Activator | 648 |
| <input type="checkbox"/> TNS RSX | 450 |
| <input type="checkbox"/> TNS #ONE | 450 |
| <input type="checkbox"/> TNS Activator 2.5 | 450 |

| | |
|---|-----|
| <input type="checkbox"/> Meyra Smart F * | 450 |
| <input type="checkbox"/> Meyra Nano * | 450 |
| <input type="checkbox"/> Meyra Avanti Pro * | 450 |
| <input type="checkbox"/> Meyra Hurracane * | 450 |
| <input type="checkbox"/> ProAktiv Traveler * | 450 |
| <input type="checkbox"/> ProAktiv Speedy * | 450 |
| <input type="checkbox"/> Wheels2move Panthera * | 450 |
| <input type="checkbox"/> TiLite TR, TRA | 330 |
| <input type="checkbox"/> TiLite T, Z, ZR, ZRA | 330 |

* het V-frame mag een maximale hoek van 5° hebben

** rond frame, tot 02-2020

Bij bestelling van een Attitude voor een bestaande Helium met handbike asplaat, dient het onderdeel hieronder meebesteld te worden:

066983 Frame versterkingskit t.b.v. Empulse Attitude € 397
Serienummer Quickie Helium:

| | | |
|-----------|--|----|
| ATT090213 | <input type="checkbox"/> ATTITUDE - zonder nieuwe rolstoelbestelling | gm |
| ATT090214 | <input type="checkbox"/> ATTITUDE met rolstoelorder - bestelling op apart orderformulier (1) | gm |

Built-4-Me

| | | |
|------------------|---|-------|
| FMG-MA03-3201-01 | <input type="checkbox"/> Aanpassing lengte dockingsysteem -20 tot +60 mm (2) | € 370 |
| | <input type="checkbox"/> -20 mm <input type="checkbox"/> 0 mm <input type="checkbox"/> +20 mm <input type="checkbox"/> +40 mm <input type="checkbox"/> +60 mm | |

ROLSTOEL VOORFRAME BREEDTE
opgemeten vanaf buitenkant framebuis tot buitenkant framebuis

| | | | | | | | | | | | |
|--------------------------|--------------------------|--------------------------|--------------------------|--------------------------|--------------------------|--------------------------|--------------------------|--------------------------|--------------------------|--------------------------|--------------------------|
| <input type="checkbox"/> | <input type="checkbox"/> | <input type="checkbox"/> | <input type="checkbox"/> | <input type="checkbox"/> | <input type="checkbox"/> | <input type="checkbox"/> | <input type="checkbox"/> | <input type="checkbox"/> | <input type="checkbox"/> | <input type="checkbox"/> | <input type="checkbox"/> |
| 260 | 280 | 300 | 320 | 340 | 360 | 380 | 400 | 420 | 440 | 460 | |

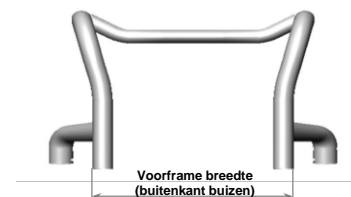

(1) rolstoelen kunnen worden meebesteld samen met de Attitude, voeg deze toe aan dezelfde inkooporder. De Attitude wordt dan samen met de rolstoel verzonden.

(2) positie -20mm is dichterbij het frame / positie +60 mm is verder van het frame.

ATTITUDE Manual / Hybrid - crankpositie range

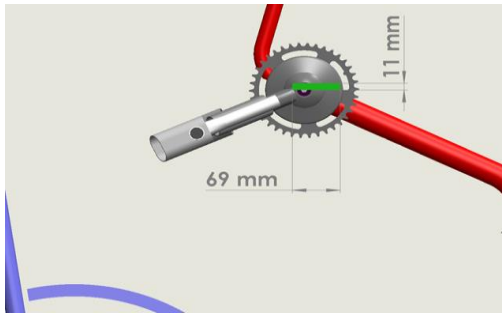

ATTITUDE Manual / Hybrid vork - hoek en diepte instelbaar

ATTITUDE Manual / Hybrid - crank positie range met optie ATT080035 "Vork, diepte en hoek instelbare crank positie"

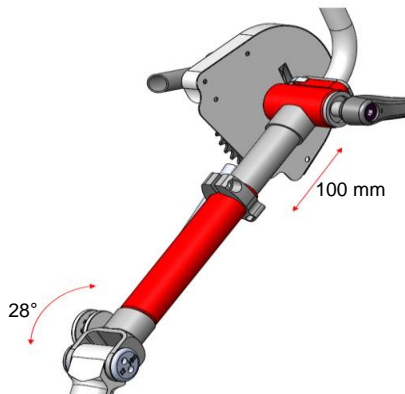

Diepte instelbaar: 100mm (+/- 50mm compared to standard fork)

Hoek instelling: van 0° (parallel tot de grond) tot 28°

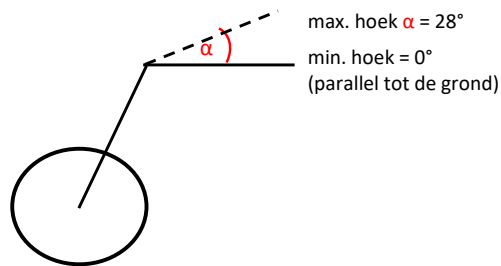

ATTITUDE Power - stuurpositie range

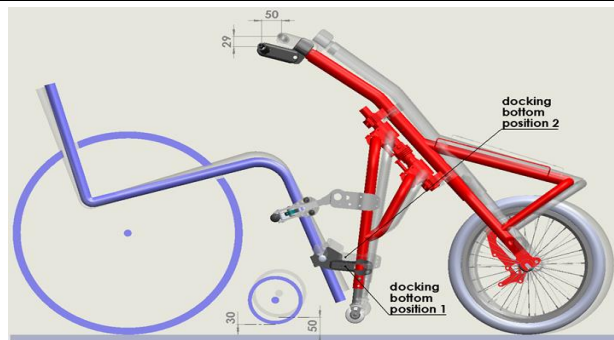
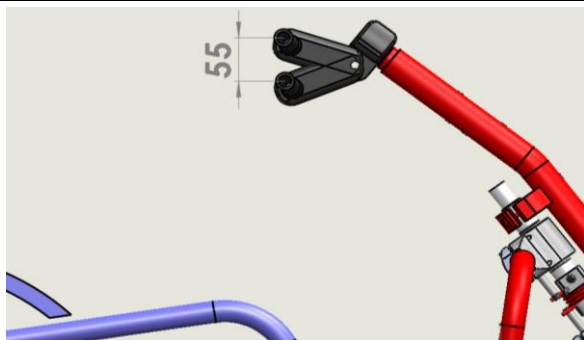

FMG-MA03-3201-01 Adaptation link -20 tot + 60 mm

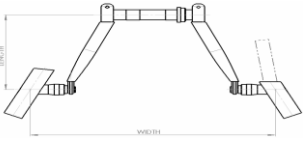

| EMPULSE Attitude | | Manua | Hybrid | Power | € |
|--|---|-------|--------|-------|-------|
| <input checked="" type="checkbox"/> Standaard <input type="checkbox"/> Geen meer-/minderprijs <input type="checkbox"/> Meerprijs | | | | | |
| VORK | | | | | |
| ATT080034 | <input type="checkbox"/> Vork standaard | ✓ | ✓ | ✓ | gm |
| ATT080035 | <input type="checkbox"/> In hoek en diepte instelbare crank-positie | ✓ | ✓ | - | gm |
| BANDEN | | | | | |
| ATT070104 | <input type="checkbox"/> Marathon Plus Evolution | ✓ | ✓ | - | gm |
| ATT070110 | <input type="checkbox"/> Schwalbe Mountain Bike | ✓ | ✓ | ✓ | gm |
| ATT070111 | <input type="checkbox"/> Schwalbe Big Apple | - | - | ✓ | gm |
| VERSNELLINGEN | | | | | |
| Attitude Manual | | | | | |
| ATT070043 | <input checked="" type="checkbox"/> 8 versnellingen (naaf), incl terugtraprem (geen schijfrem) | ✓ | - | - | std |
| Attitude Hybrid | | | | | |
| ATT070045 | <input checked="" type="checkbox"/> 10 versnellingen (derailleur), trigger shift | - | ✓ | - | std |
| CRANK EN HANDVATTEN - speciale lengte, breedte en uitvoeringen via B4M | | | | | |
| ATT080022 | <input type="checkbox"/> V-crank, standaard Lengte: 170 mm Breedte: 470 mm  | ✓ | ✓ | - | gm |
| ATT080023 | <input checked="" type="checkbox"/> Handvat, verticaal, 10°, diameter 30 mm | ✓ | ✓ | - | std |
| Built-4-Me | | | | | |
| ATT080027 | <input type="checkbox"/> Quad, handondersteuning | ✓ | ✓ | - | 242 |
| ATT080028 | <input type="checkbox"/> Quad, armondersteuning | ✓ | ✓ | - | 254 |
| ATT080024 | <input type="checkbox"/> Handvat, verticaal, 10°, diameter 40 mm | ✓ | ✓ | - | gm |
| ATT080025 | <input type="checkbox"/> Handvat, verticaal, 25°, ovaal, diameter 37 x 21 mm | ✓ | ✓ | - | 146 |
| ATT080026 | <input type="checkbox"/> Handvat, verticaal, 25°, ovaal, diameter 47 x 32 mm | ✓ | ✓ | - | 146 |
| STUURSTANG | | | | | |
| ATT080050 | <input checked="" type="checkbox"/> Standaard stuurstang; hoogte instelbaar | - | - | ✓ | std |
| ATT080051 | <input type="checkbox"/> Multi-instelbare stuurstang; hoogte- en diepte instelbaar | - | - | ✓ | 481 |
| SCHIJFREEM - tevens parkeerrem | | | | | |
| ATT060050 | <input type="checkbox"/> Schijfrem bediend door remhendel <i>(niet i.c.m. ATT070043)</i> | ✓ | ✓ | ✓ | gm |
| ATT060053 | <input type="checkbox"/> Performance remhendel (eenvoudig instelbaar en aanpasbaar) | ✓ | ✓ | ✓ | 45 |
| ATT060102 | <input type="checkbox"/> Rem, rechts gemonteerd | ✓ | ✓ | ✓ | gm |
| ATT060101 | <input type="checkbox"/> Rem, links gemonteerd | ✓ | ✓ | ✓ | gm |
| ATT060052 | <input type="checkbox"/> 2 remmen plus parkeerrem <i>(niet i.c.m. ATT070043) (parkeerrem is een velgrem, niet een schijfrem)</i> | ✓ | ✓ | - | 174 |
| ATT060051 | <input type="checkbox"/> Terugtraprem i.c.m. schijfrem <i>(niet i.c.m. ATT070043 & ATT080035)</i> | ✓ | ✓ | - | 447 |
| SNELHEID T.B.V. POWER | | | | | |
| ATT000025 | <input checked="" type="checkbox"/> Snelheid max. 6 km/u | - | - | ✓ | std |
| ATT000027 | <input type="checkbox"/> Snelheid max. 10 km/u | - | - | ✓ | gm |
| ATT000028 | <input type="checkbox"/> Snelheid max. 15 km/u | - | - | ✓ | gm |
| ACCU - oplader is altijd inclusief | | | | | |
| ATT160020 | <input checked="" type="checkbox"/> Accu, Lithium-ion, 17 Ah | - | ✓ | - | std |
| ATT090088 | <input type="checkbox"/> Additionele accu, Lithium-ion, 17 Ah | - | ✓ | - | 1.268 |
| ATT090091 | <input type="checkbox"/> Additionele oplader, Hybrid | - | ✓ | - | 249 |
| ATT160021 | <input checked="" type="checkbox"/> Accu, Lithium-ion, 9 Ah | - | ✓ | ✓ | std |
| ATT160022 | <input type="checkbox"/> Accu, Lithium-ion, 14 Ah | - | ✓ | ✓ | 426 |
| ATT090086 | <input type="checkbox"/> Additionele accu, Lithium-ion, 9 Ah | - | ✓ | ✓ | 721 |
| ATT090087 | <input type="checkbox"/> Additionele accu, Lithium-ion, 14 Ah | - | - | ✓ | 1.017 |
| ATT090089 | <input type="checkbox"/> Additionele oplader, Power | - | - | ✓ | 138 |
| ACCESSOIRES | | | | | |
| ATT090074 | <input checked="" type="checkbox"/> Voor- & achterverlichting | ✓ | ✓ | ✓ | std |
| ATT090080 | <input checked="" type="checkbox"/> Snelheidsmeter <i>(geïntegreerd in het scherm van de Hybrid en Power)</i> | ✓ | ✓ | ✓ | std |
| ATT090095 | <input checked="" type="checkbox"/> Spatbord aangeschroefd, zwart | ✓ | ✓ | ✓ | std |
| ATT090085 | <input checked="" type="checkbox"/> Bel | ✓ | ✓ | ✓ | std |
| ATT090067 | <input type="checkbox"/> Achteruitkijkspiegel | ✓ | ✓ | ✓ | 58 |
| ATT090081 | <input type="checkbox"/> Bidonhouder | ✓ | ✓ | ✓ | 33 |
| ATT090082 | <input type="checkbox"/> Bagagedrager voor fietstas | ✓ | ✓ | ✓ | 191 |
| ATT090024 | <input type="checkbox"/> Handluchtcompressor (0 - 11 bar) | ✓ | ✓ | ✓ | 133 |
| ATT090084 | <input type="checkbox"/> Tractiegewicht 5kg (afneembaar) | ✓ | ✓ | ✓ | 118 |
| ATT090041 | <input type="checkbox"/> Gereedschapset | ✓ | ✓ | ✓ | 29 |
| ATT090096 | <input type="checkbox"/> Bescherfolie t.b.v. rolstoel of Attitude | ✓ | ✓ | ✓ | 45 |

EMPULSE Attitude

ATTITUDE opties



Schwalbe Marathon Plus Evolution



Schwalbe Mountain Bike



Big Apple



Vork, hoek en diepte instelbare crank (Attitude Manual & Hybrid)



Shifter, trigger shift



Shifter, grip shift, 10 versnellingen



Stuurstang multi-instelbaar (alleen Attitude Power)



Hendel, verticaal, 10°, diameter 30 mm



Quad, handondersteuning



Quad, armondersteuning



Hendel, verticaal, 25°, ovaal



Performance rem



Terugtraprem



Spatbord



Spiegel



Bidonhouder



Bagagedrager voor fietstas



Handluchtcompressor (0 - 11 bar)



Tractiegewicht 5kg (afneembaar)



Bel



Gereedschapset

EMPULSE Attitude

◇ = Standaard

○ = Geen meer-/minderprijs

□ = Meerprijs

€

KLEUR

(frame-, kettingkast- en crankkleur zijn apart van elkaar te kiezen)

| Framekleur | Kettingkast (1) | Crank (1) |
|--|--|--|
| ATT100102 ○ 02 Brilliant Silver | ATT100802 ○ 02 Brilliant Silver | ATT100902 ○ 02 Brilliant Silver |
| ATT100103 ○ 03 Silver Matt | ATT100803 ○ 03 Silver Matt | ATT100903 ○ 03 Silver Matt |
| ATT100105 ○ 06 Sun Yellow | ATT100805 ○ 06 Sun Yellow | ATT100905 ○ 06 Sun Yellow |
| ATT100110 ○ 14 Glossy Blue | ATT100810 ○ 14 Glossy Blue | ATT100910 ○ 14 Glossy Blue |
| ATT100111 ○ 15 Brilliant Marine | ATT100811 ○ 15 Brilliant Marine | ATT100911 ○ 15 Brilliant Marine |
| ATT100112 ○ 16 Matt Marine | ATT100812 ○ 16 Matt Marine | ATT100912 ○ 16 Matt Marine |
| ATT100113 ○ 19 Brilliant Purple | ATT100813 ○ 19 Brilliant Purple | ATT100913 ○ 19 Brilliant Purple |
| ATT100115 ○ 21 Ruby Red | ATT100815 ○ 21 Ruby Red | ATT100915 ○ 21 Ruby Red |
| ATT100116 ○ 22 Brilliant Red | ATT100816 ○ 22 Brilliant Red | ATT100916 ○ 22 Brilliant Red |
| ATT100117 ○ 23 Matt Red | ATT100817 ○ 23 Matt Red | ATT100917 ○ 23 Matt Red |
| ATT100118 ○ 24 Tutti Frutti Orange | ATT100818 ○ 24 Tutti Frutti Orange | ATT100918 ○ 24 Tutti Frutti Orange |
| ATT100120 ○ 27 Graphite Metallic | ATT100820 ○ 27 Graphite Metallic | ATT100920 ○ 27 Graphite Metallic |
| ATT100122 ○ 29 Classic Black | ATT100822 ○ 29 Classic Black | ATT100922 ○ 29 Classic Black |
| ATT100123 ○ 31 Matt Black | ATT100823 ○ 31 Matt Black | ATT100923 ○ 31 Matt Black |
| ATT100124 ○ 32 Signal White | ATT100824 ○ 32 Signal White | ATT100924 ○ 32 Signal White |
| ATT100125 ○ 33 Pink | ATT100825 ○ 33 Pink | ATT100925 ○ 33 Pink |
| ATT100126 ○ 34 Dark Chocolate Metallic | ATT100826 ○ 34 Dark Chocolate Metallic | ATT100926 ○ 34 Dark Chocolate Metallic |
| ATT100127 ○ 35 Sky Blue | ATT100827 ○ 35 Sky Blue | ATT100927 ○ 35 Sky Blue |
| ATT100128 ○ 36 Cyan Metallic | ATT100828 ○ 36 Cyan Metallic | ATT100928 ○ 36 Cyan Metallic |
| ATT100129 ○ 37 Mars Red (Orange) | ATT100829 ○ 37 Mars Red (Orange) | ATT100929 ○ 37 Mars Red (Orange) |
| ATT100132 ○ 40 Kiwi Green | ATT100832 ○ 40 Kiwi Green | ATT100932 ○ 40 Kiwi Green |
| ATT100133 ○ 41 Flamingo Glitter | ATT100833 ○ 41 Flamingo Glitter | ATT100933 ○ 41 Flamingo Glitter |
| ATT100134 ○ 42 Matt Anthracite | ATT100834 ○ 42 Matt Anthracite | ATT100934 ○ 42 Matt Anthracite |
| ATT100145 ○ 46 Mamba Green | ATT100808 ○ 46 Mamba Green | ATT100908 ○ 46 Mamba Green |

(1) alleen i.c.m. Attitude Manual en Hybrid

"ATTITUDE" STICKERKLEUR

| | |
|--------------------|----|
| ATT100550 ○ Zwart | gm |
| ATT100551 ○ Zilver | gm |
| ATT100552 ○ Oranje | gm |

BUILT-4-ME

FMG-MA03-3222-01 □ Eenhandige ontgrendeling brackets € 217



OPMERKINGEN



Empulse ATTITUDE - Basisprijs

| | |
|--------------------|---------|
| Prijs optie | € |
| Exclusief BTW | € |
| BTW | € |
| Totaalprijs | € |

Sunrise Medical Customer Service
T: 088 - 50 123 45
E: cs@sunrisemedical.nl

Voor meer informatie
bezoek onze website
www.SunriseMedical.nl
© Sunrise Medical 2025